

N NARGESA®

HORIZONTAL HYDRAULIC PRESS BRAKE

PP200CNC



 4.0 Technology



NEW

50  **years**
manufacturing industrial machinery

HORIZONTAL HYDRAULIC PRESS BRAKE

The versatility of the 20 Tons, Horizontal Press Brake NARGESA PP200CNC allows us to bend, fold, bend, cut, form, enlarge and reduce flaring, swagging, assembling... all kinds of metal materials such as iron, steel, stainless, copper, brass, aluminium...

REQUEST QUOTATION

Please fill up the following form. We will contact you in less than 24 hours.

Working days

VIDEO MACHINE OPERATION

Machine performance video

SOME OF OUR REMARKABLE CUSTOMERS



SAMPLES OF JOBS DONE WITH HORIZONTAL HYDRAULIC PRESS BRAKE PP200CNC

Pipe bending at fixed radius up to 150° could be considered one of the good features of these presses

Cutting, piercing and punching flat bars or metal sheets turn this horizontal bending press into a punching shears machine

Stretching and reducing pipes on the ends in order to make parts that fit or weld later

It is also a solution to bend different profiles at different radius and keeping the ends straight, like when manufacturing handles and flanges

Cold forge uses horizontal presses to make and form different shapes of balusters

Tube notching to assemble at 90 degrees

Folding operations with wrought iron machines permit to completely bend the parts or pieces unlike conventional flat bar section bending machines

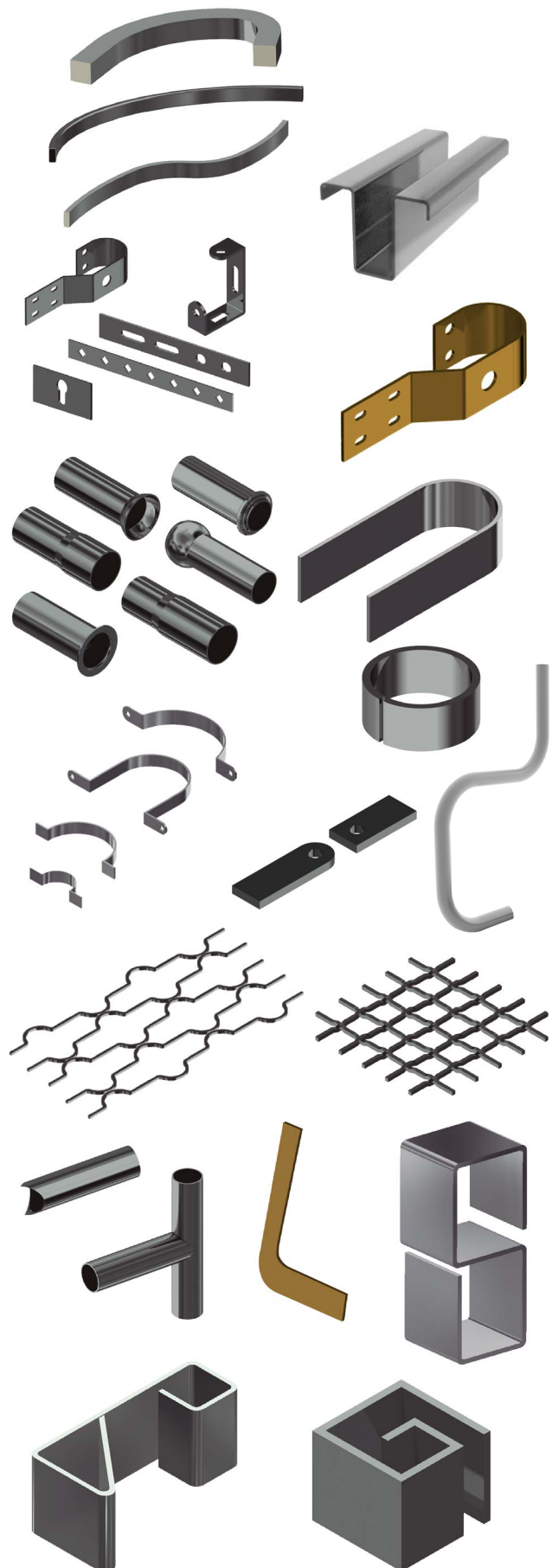

TECHNICAL FEATURES

Its robustness, versatility, easy handling and 4.0 Technology are just four of the best features our hydraulic horizontal bending machine has.

- Folding operation with no risk of damaging the punches and dies with thick materials unlike conventional press brakes.
- Folding flat bars and sheets into completely close shapes. Conception of this horizontal bending press brake allows to make folding operations impossible to be carried out on a conventional press brake.
- Fast tool change, punches and dies: This change does not take more than 30 seconds most of the times.
- A set of punch and folding die is supplied along with the machine.
- Performance by a safety double activation hold pedal.
- Low noise level, improving the quality of work of the operator.
- The machine is shipped completely assembled and ready to work.
- Palletized lower bench to easily transport the machine up to its working or storage site.
- Dies support shelf included.
- Lateral stop to place it right or left.

** All our products are manufactured in our facilities in Spain. Hydraulic and electrical components are all standard from the best leading European trademarks with technical support all over the world: Rexroth, Bosch, Roquet, Schneider Electric, LG, Telemecanique, Pizzato...*

The new
ECOMODE
of our latest products
saves energy and
contributes to the
conservation of the
environment

Nowadays, we know the remarkable importance of saving energy. This is the main reason why our new machinery incorporates an "ECO mode" that automatically disconnects the electrical parts that generate greater energy consumption if a period of inactivity is detected. Thus, when it is necessary to restart the operation, all you have to do is press the pedal to continue working.

We strongly believe that this feature is a core point both for the savings of our clients and for the sustainability of our planet, since we are a company very committed to the environment.



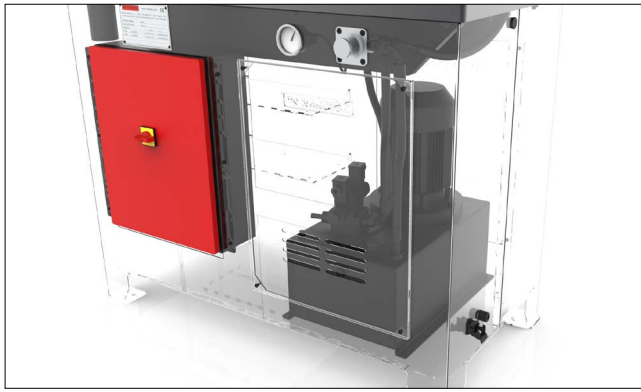

Hydraulic System

Monoblock hydraulic power unit with positioning and pressure regulation valves

The hydraulic system can be regulated by means of pressure adjustment valves that affect the piston force.

Pressure regulator with pressure gauge that allows to control the force carried out at any time.

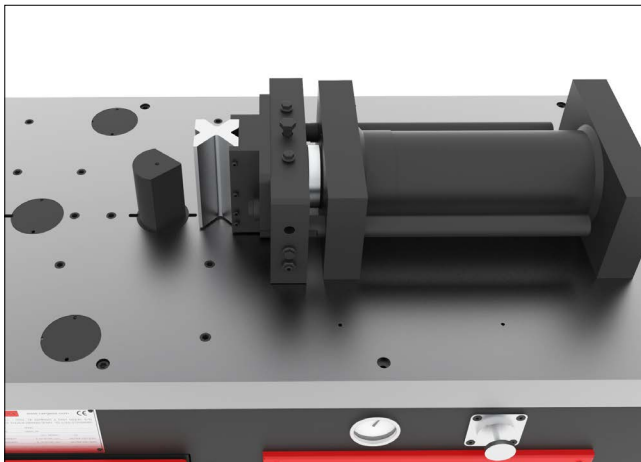

Guided hydraulic cylinder

The hydraulic cylinder placed on the work bench allows us to transfer all the force directly on the tools.

Fully guided hydraulic piston to prevent any bending during the folding operation.



Cylindrical fastening bolts

Cylindrical fastening bolts easy to install, to guarantee maximum firmness to the tools during machining operations.

Plugs to prevent the residues of the folding from entering inside the machine.

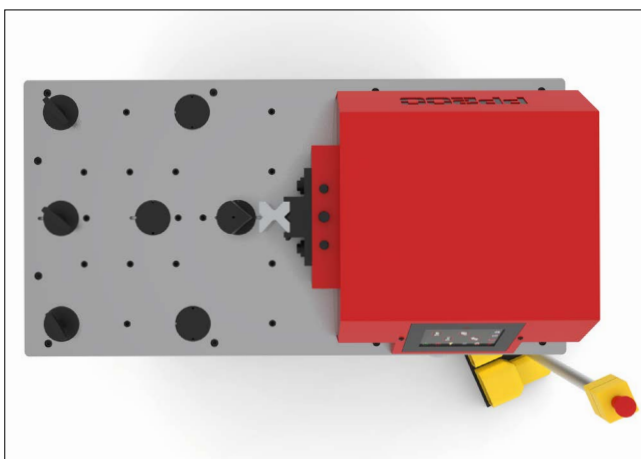

Work table without frame

The work bench is frameless, this is great for the movement of the parts to be machined for there isn't any element that obstructs its movement. The table is manufactured in a 60mm monoblock of welded steel, stabilized and machined.

The operator's working position must be at the side of the machine for accomplishing a better vision and control, as well as greater safety for the user since he will be outside the radius of action of the tools.



ESA S625 CONTROL PANEL

Nargesa horizontal press brakes have a 7" color touch screen control, **very intuitive and easy to handle, with the latest 4.0 technology and a more comfortable and accurate regulation.**

We only have to introduce the material, the thickness, the bending angle, choose the punch and the die from the library and the control will program the rest of the parameters automatically.

These are some of the most relevant features of this control system.

- > Stores up to 10,000 programs.
- > Up to 50 different angles on the same piece can be programmed.
- > Dimensions may be programmed in inches or millimetres.
- > A library of available dies with the possibility of programming new ones.
- > Library of materials and thicknesses available with the possibility of programming new options.
- > The CNC can be supplied in more than 20 different languages.
- > Automatic control of the angle to fold, in degrees.
- > 9.8mm/s working speed and 35mm/s reversing speed
- > Manual or automatic operation.
- > Automatic elastic recovery correction (springback).
- > Piece counter.
- > 4.0 Technology.
- > On-screen alarm diagnostics.
- > Preventive maintenance warning.
- > Can be remotely connected by the manufacturer without having to travel to the machine site.
- > 7" colour touch-screen with 800 x 480 resolution.
- > 128 MB silicon disk.
- > 2 analogue inputs, 12 bit resolution.
- > 16 digital inputs (24 Vdc).
- > 16 digital outputs (24 Vcc, 0.7 A max.) Protected against overloads and short circuits.
- > 1 RS232 serial port.
- > 1 CAN port with 9 D-Sub F connector contacts.
- > 24 Vdc power source.
- > 1 USB port.
- > 1 Ethernet port.







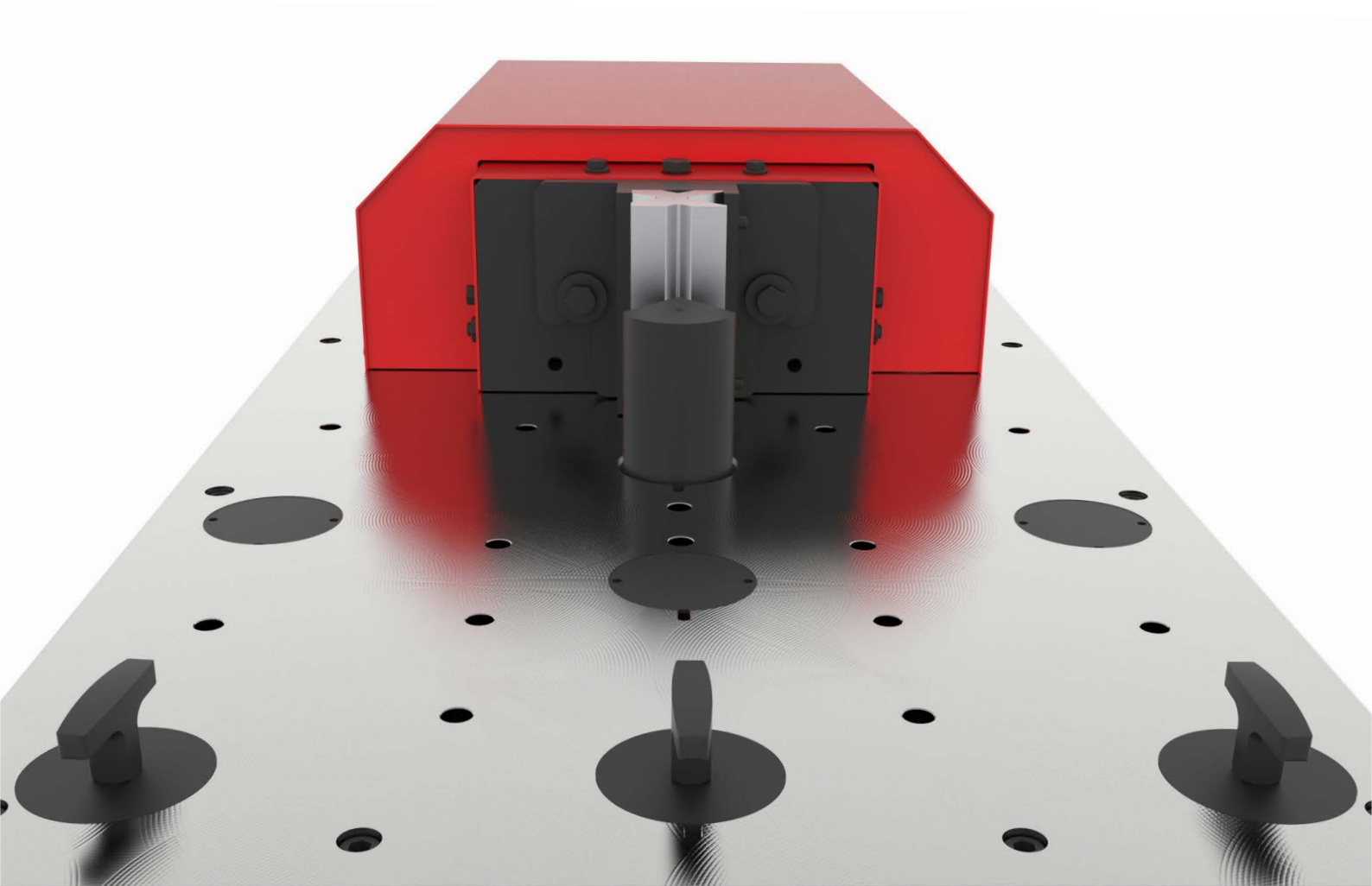







The advantage of the Horizontal Bending Press PP200CNC is to have a really simple head drive so that all our customers can adapt any die manufactured by themselves

To add more options when fastening tools, the workbench has a series of clamping holes distributed throughout the area to ease up the fixing.

If you need a special die, Prada Nargesa offers a technical support to all our customers who wish to make their own tools. Moreover, we have an extra service for designing and manufacturing exclusive tooling on request, for each of the machines we manufacture.



DETAILED FEATURES

	Working strength	20 Ton. (200 KN).
	Working speed	9,8 mm/s.
	Return speed	35 mm/s.
	Maximum displacement	250 mm.
	Repeatability	0,05 mm.
	Bench size	600x1170 mm.
	Working height	950 mm.
	Engine power	2.2 KW / 3 CV a 1400 r.p.m.
	Electric Tension	230 / 400 V three-phased <i>For Single-phased machines, please ask the manufacturer.</i>
	Intensity	9/5 A.
	Hydraulic pressure	50 a 215 Kg/cm ² .
	Hydraulic pump	7,5 litres/minute
	Tank Capacity	27 litres
	Machine dimensions	660x1180x1130 mm.
	Weight	665 Kg.

EXTERNAL DIMENSIONS

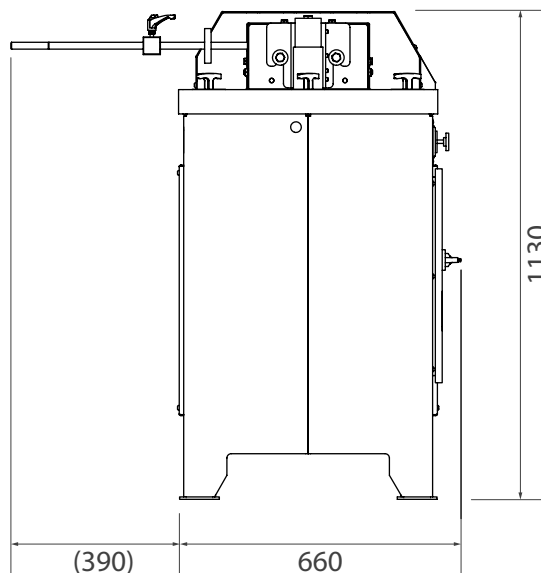
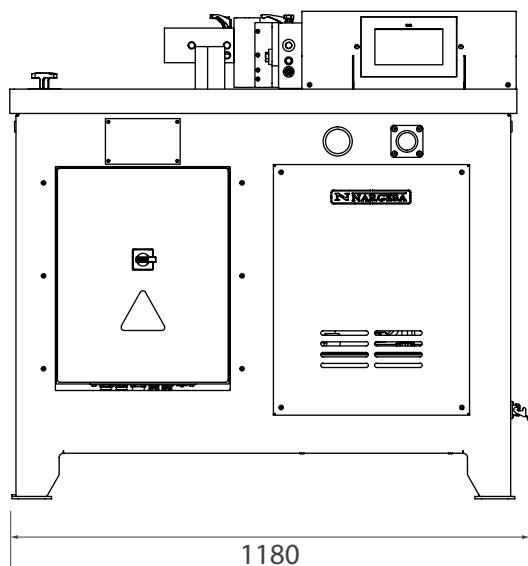

CHARACTERISTICS OF THE PACKAGING

- Tariff Item Code: 84622290
- The machine is delivered completely mounted.
- Packaging with wooden pallet NIMF15 and 3-layered cardboard box suitable for sea freight.
- Optional: Complete wooden packaging NIMF15.

PP200CNC

Width	930 mm
Length	1300 mm
Height	1500 mm
Volume	1,81 m3
Nett weight	665 Kg
Gross Weight	712 Kg

STANDARD ACCESSORIES DELIVERED WITH THE MACHINE

Folding die at 161 mm • V 16, 22, 35, 50 mm



> Folding or bending die up to 161mm with 4 openings (16, 22, 35, 50mm) and a punch of 80°. This multi-V die allows 1mm up to 8mm sheet to be folded. The 70mm outer diameter punch allows to make completely closed shapes to a minimum of 75mm inner wing.



Folding die reference: 125-16-01-00006

Folding punch reference: 131-16-01-00041

V 16: Sheet from 1 to 3mm

V 22: Sheet from 2 to 4mm

V 35: Sheet from 3 to 6mm

V 50: Sheet from 4 to 8mm

Max. Folding length: 161mm

Max. Folding thickness: 8mm

[Download folding chart](#)

OPTIONAL ACCESSORIES

Baluster forming die 01

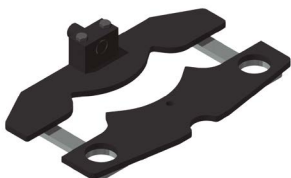

REF: 140-16-01-00001

> Die to form cold forging balusters for grills, gates, fences, handrails...

For other shapes or capacities, request the manufacturer.

Optional tooling.



Max. width	Thickness	Die length	Weight
20mm	4, 5, 6, 8mm	656mm	21Kg

Ring forming

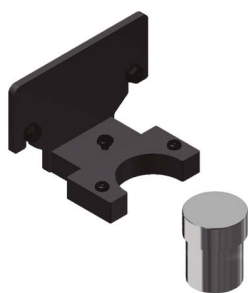

REF: 140-16-01-00003

> Die to form rings or English banister railing, used as ornamental piece in forging railings, gates, fences... For bars bonding.

For other shapes or capacities, request the manufacturer.

Optional tooling.

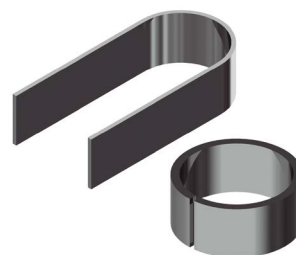

Max. width	Thickness	Outer sizes	Weight
50mm	6mm	90mm	9,3Kg

Baluster forming die 04

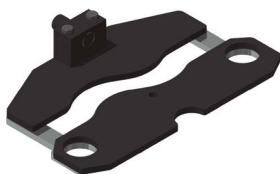

REF: 140-16-01-00004

> Die to form cold forging balusters for grills, gates, fences, handrails...

For other shapes or capacities, request the manufacturer.

Optional tooling.



Square sizes	Die length	Weight
5, 6, 8, 10, 12, 14, 16, 18mm	600mm	20,5 Kg

Bending tool for big radius

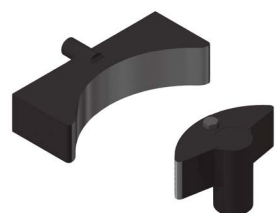

REF: 140-16-01-00006

> Die to form curves in flat bars, pipes, bars or profiles at big radius. It's perfect for bending small series or special parts without requiring a specific custom mould.

Optional tooling.



Max. bar capacity	Max. pipe capacity	Min. diameter	Max. diameter
40mm or 1 1/2"	80x80 mm or 3"	300mm	There is no maximum

Baluster forming die 08



REF: 140-16-01-00008

> Die to form cold forging balusters for grills, gates, fences, handrails...

For other shapes or capacities, request the manufacturer.

Optional tooling.



Max. width	Thickness	Die length	Weight
20mm	4, 5, 6, 8mm	650mm	19,5Kg

Baluster forming die 09



REF: 140-16-01-00009

> Die to form cold forging balusters for grills, gates, fences, handrails...

For other shapes or capacities, request the manufacturer.

Optional tooling.



Flat bar size	Die length	Weight
5, 6, 8, 10, 12mm	522mm	22Kg

Baluster forming die 10



REF: 140-16-01-00010

> Die to form cold forging balusters shaped parts for grills, so called "belly top railing".

For other shapes or capacities, request the manufacturer.

Optional tooling.

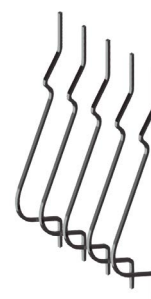

Flat bar size	Die length	Weight
12mm	1165mm	50Kg

Baluster forming die 11

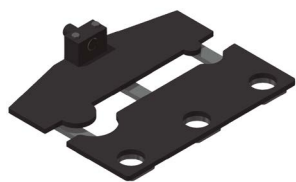

REF: 140-16-01-00011

> Die to form cold forging balusters for grills, gates, fences, handrails...

For other shapes or capacities, request the manufacturer.

Optional tooling.



Flat bar size	Die length	Weight
6, 8, 10, 12mm	760mm	32,5Kg

Twisted bars forming die

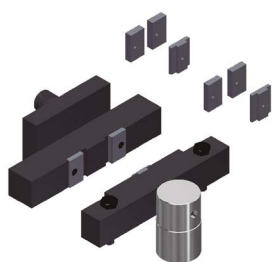

REF: 140-16-01-00013

> Die to bend metal plate, flat bar or square bar to obtain a nice braid twisted effect. It's very used to make fences and grills

> For flat bar from to 6, 12 and 14mm.

For different sizes, please ask the manufacturer

Optional tooling.

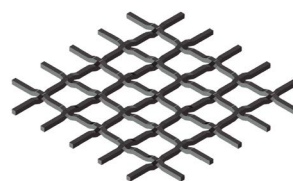

Max. capacity	Min. capacity	Weight
Square 14 mm	2x40 mm metal sheet	18Kg

Flat bar cutting tooling 100x10mm

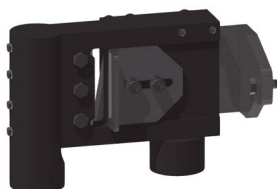

REF: 140-16-01-00014

> Flat bar and metal sheet cutting die up to 100mm through a maximum thickness of 10mm in mild steel.

Optional tooling.

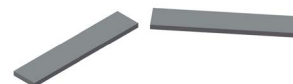

Max. cutting length	Max. cutting thickness	Weight
100mm	10mm	23Kg

Tool to shape pipe ends



REF: 140-16-01-00016

> Basic die to modify the ends of the tubes for their assembly. You can make all kinds of shapes and flaps according to the customer needs.

Weight: 110 Kg approx.

For special forms consult the manufacturer.

Optional tooling.

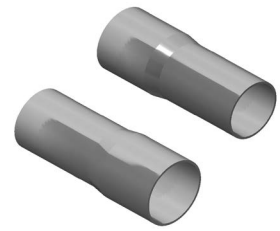

Diameter reduction tools



> Composed by the clamp holder to reduce tube and the reduction clamp.

> This accessory is adapted to the Tooling to shape pipe ends, to perform the operation of reducing the ends of the tubes, for its coupling.

Optional tooling.

We can find the different sizes in the following PDF file



Diameter expansion tools



> Composed by the Clamp Holder to Expand, Expansion Mandrel and the Expander Clamp.

> This accessory is adapted to the Tooling to shape pipe ends, to perform the operation of expanding the ends of the tubes, for its coupling

Optional tooling.

We can find the different sizes in the following PDF file



Die to straighten out profiles

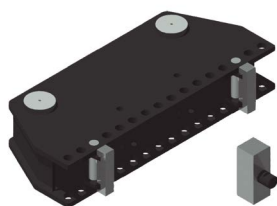

REF: 140-16-01-00017

> Tool used to bend straight profiles or parts. It is adjustable to different capacities according to the profiles.

Maximum capacity: H 150mm.

Weight: 72Kg.

Optional tooling.



Baluster forming die 20

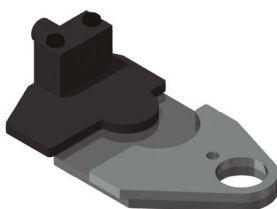

REF: 140-16-01-00011

> Die to form cold forging balusters for grills, gates, fences, handrails...

For other shapes or capacities, request the manufacturer.

Optional tooling.

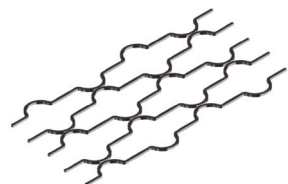

Square sizes	Circumference size	Weight
12mm	760mm	32,5Kg

Punching die

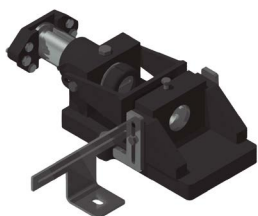

REF: 140-16-01-00022

> Punch-holder die, compatible with our Nargesa brand punches.

Gooseneck: 54 mm.

Free distance of tooling: 95 mm.

Weight: 52 Kg.

Optional tooling.

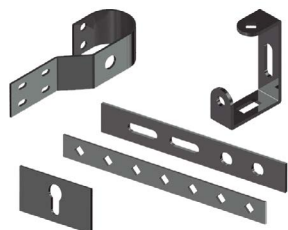

	Round	Square	Rectangular	Oval
Capacidad máx. Punzonado	43mm	35mm	20x34mm	21x40mm

Promecam punch holder

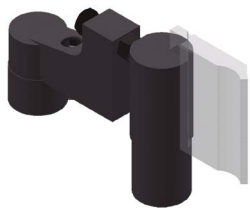

REF: 140-16-01-00023

- > Punch holder for all kind of punches for Promecam bending or folding press.
- > Compatible with any Promecam punch.



Optional tooling

Max. Folding length	Weight
150mm	14kg

Clamp forming die



REF: 140-16-01-00024

- > Die to form all kinds of clamps. This tooling is manufactured according to the user's needs thus it is required to have a technical drawing or a sample piece.



Maximum capacity: 100x4mm.

Optional tooling.

Bar clamps forming die

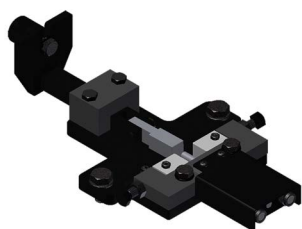

REF: 140-16-01-00028

- > Clamp forming die, used to manufacture the clamps used to join different forging bars with no need to get them welded.

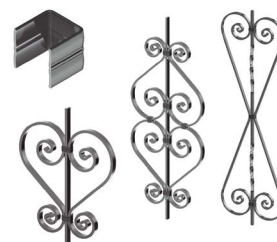

Optional tooling.

Max. capacity	Weight
25x5mm	9Kg

Special punches

Folding punches to bend special pieces of small sizes or folded up to 30°.



Folding Punch D70 30°
REF: 140-16-01-00025
Max. Folding length: 100mm.
Punch degrees: 30°
Punch diameter: 70mm.
Weight: 3 Kg approx.

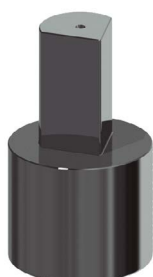
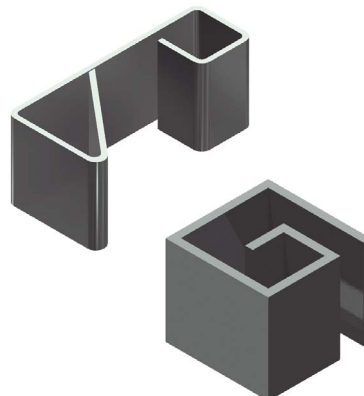

Folding Punch D40 80°
REF: 140-16-01-00026
Max. Folding length: 60mm.
Punch degrees: 80°
Punch diameter: 40mm.
Weight: 3 Kg approx.

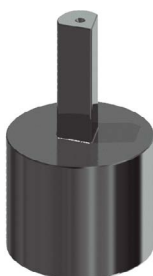

Folding Punch D22 80°
REF: 140-16-01-00027
Max. Folding length: 60mm.
Punch degrees: 80°
Punch diameter: 22mm.
Weight: 3 Kg approx.

Optional tooling.

Forming die adaptor

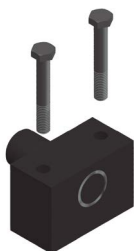

REF: 140-16-01-00029
> It is an exchangeable fitting device for the forming dies, suitable for each of the different baluster forming tools. It is advisable to get one in order to work with the specified dies.

Weight: 3,1 Kg.

Optional tooling suitable for all forming dies.

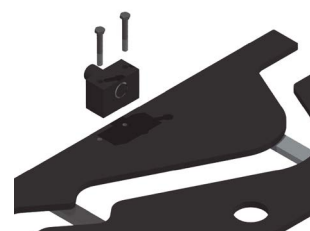

Punzones Promecam

Promecam punches of different shapes to bend and manufacture complex part. There are a lot more shapes, please consult the manufacturer.

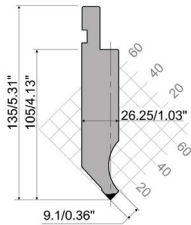

Punch Promecam PS.135.85.R08 PP200

REF: 140-16-01-00030

Folding length: 161mm.

Weight: 3,2 Kg.

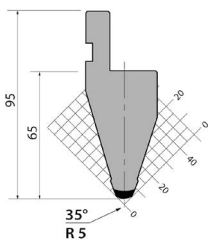
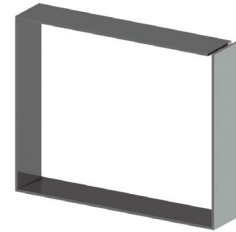

Punch Promecam P.95.35.R5 PP200

REF: 140-16-01-00031

Folding length: 161mm.

Weight: 2,3 Kg.

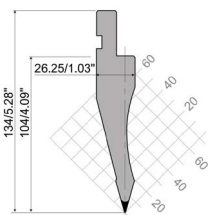
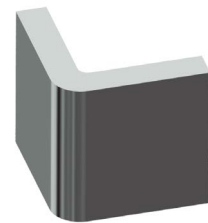

Punch Promecam PS.134.30.R08 PP200

REF: 140-16-01-00032

Folding length: 161mm.

Weight: 2,7 Kg.

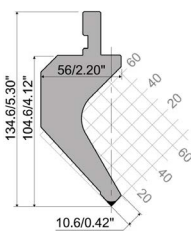

Punch Promecam PK.135.85.R08

REF: 140-16-01-00038

Folding length: 161mm.

Weight: 4,4 Kg.



Optional tooling.

Dies to fold thick metal sheet

Promecam dies of different openings to fold sheets, flat bars or thicker plate sections up to 15mm. in order to fold even thicker sizes, ask the manufacture.



Folding die T80.25.35 PP200
REF: 140-16-01-00036
Folding length: 161mm.
Thickness: From 1,5 to 5mm.
Weight: 4 Kg.

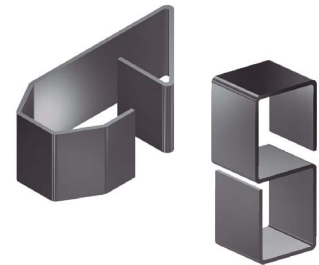

Folding die M75-85-63 PP200
REF: 140-16-01-00033
Folding length: 161mm.
Thickness: From 5 to 10mm.
Weight: 5 Kg.

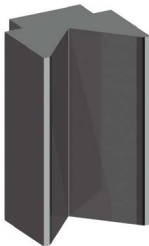

Folding die M80-85-80 PP200
REF: 140-16-01-00034
Folding length: 161mm.
Thickness: From 6 to 12mm.
Weight: 6 Kg.

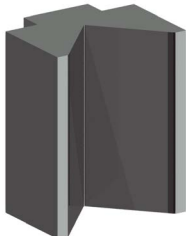

Folding die M95-80-100 PP200
REF: 140-16-01-00035
Folding length: 161mm.
Thickness: From 8 to 15mm.
Weight: 9 Kg.

Optional tooling.

Round, square, oval and rectangular punches and dies



- > At Nargesa we own a wide catalogue for punches and dies of all kinds. If the size the customer needs is not in the list, we manufacture it.
- > In the PDF file you will be able to see all kinds and sizes we have.

Optional tooling.

Technical features



Pipe notching tool



- > Dies for notching pipes from $\varnothing 16$ to a $\varnothing 50$ mm. It crops the pipe end so it could be joined perpendicularly to another pipe.

Optional tooling.

Technical features



Rounding corner tool



- > Die to get metal sheet corners rounded at different radius.

Optional tooling.

Technical features

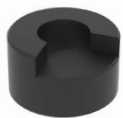

Metal tabs forming tool



- > Tool to fabricate all kinds of tabs, with or without perforation, straight or rounded... They are very used as clamps, handles etc. Starting from a metal strip, there will be obtained one piece of the desired length at every stroke.

Optional tooling.

Technical features



OUR RANGE OF MACHINERY



IRON WORKERS



SECTION BENDING
MACHINES



NON-MANDREL PIPE
BENDER



HORIZONTAL PRESS
BRAKES



TWISTING/SCROLL
BENDING MACHINES



HYDRAULIC PRESS
BRAKES



HYDRAULIC SHEAR
MACHINES



GAS FORGES



IRON EMBOSING
MACHINES



END WROUGHT IRON
MACHINES



BROACHING MACHINES



POWER HAMMERS



PRESSES FOR LOCKS

WARRANTY

Nargesa machines have 3 years warranty provided that the customer registers it in our website. Otherwise it would be only one year warranty. This one encloses any manufacturing default all along these 3 years for components. Any misuse is excluded from this condition. Labor, back and forth shipping and any eventual repair, are not included in this warranty.

Partner companies



Airpharm

SHIPMENT EVERYWHERE

Nargesa will arrange transport up to final destination, whenever the customers asks for so. There is also the possibility for the customer to arrange the shipment himself with his own agency.

TECHNICAL ASSISTANCE

All our customers have access to technical support quickly and efficiently. 90% of incidences are solved out on the phone, mail, Skype or videoconferencing in less than 24hours. In case of needing presencial technical assistance, we may as well send a technician to the customer's facilities.

Follow us on

PRADA NARGESA, S.L.

Ctra. De Garrigàs a Sant Miquel s/n
17476 Palau de Santa Eulalia (Girona) Spain
Tel. +34 972 568 085

www.nargesa.com

nargesa@nargesa.com



This information might undergo changes