

PRIJSLIJST STEPELS & MATRIJZEN TBV MUBEA, GEKA, PEDDINGHAUS, KINGSLAND

Originele Duitse kwaliteitsstempels en matrijzen voor vele machines (ook Durmazlar en Sunrise)
Stempels zijn ook op maat te produceren. Heeft u een specifieke wens, laat het ons weten!

- Verzendkosten per zending: € 10,95 (tot 4kg) / € 15,00 (410kg) / franco levering: v.a. € 350,00 netto excl. BTW
- Kleinorderkosten onder netto orderbedrag € 25,00 (excl. verzendkosten): € 10,00

Mubea

Mubea stempel

Rond	Art.nr.	Prijs
3 - 15 mm	50505 11	6,34
15,5 - 30mm	50505 21	8,95
30,5 - 40mm	50505 31	18,81
40,5 - 50mm	50505 41	32,18
50,5 - 70mm	50585 11	97,44
70,5 - 100mm	50585 21	124,63
105 - 150mm	50585 31	166,55

Sleufgatstempel	Art.nr.	Prijs
5x10 - 25.5x30 mm	50505 23	26,06
11x35 - 27x40mm	50505 33	34,56
11x45 - 27x50mm	50505 43	56,54

Stempel vierkant	Art.nr.	Prijs
4 - 21 mm	50505 22	21,41
21,5 - 28mm	50505 32	29,80
28,5 - 35mm	50505 42	44,07
40 - 50	50586 12	135,96
55 - 60	50586 22	152,96
65 - 70	50586 32	215,27

Oude opname: gelijk aan Peddinghaus nr.55

Stempel type Ø15	Art.nr.	Prijs
3 -15 mm (rond)	50516 11	10,97
15.5 -20 mm (rond)	50516 21	14,36
4 -10.5 mm (vierkant)	50516 12	18,75
5x10 -11x15 (sleufgat)	50516 13	25,74

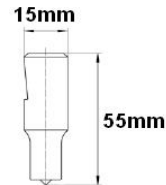

(zie ook bijlage 1 op pag. 4 t.b.v.
bepaling juiste type stempel & matrijs)
Mubea matrijs

Rond	Art.nr.	Prijs
3,2 - 15,7mm	50633 01	6,06
16,2 - 31,2mm	50638 01	10,35
31,7 - 41,2mm	50639 01	16,93
40,7 - 50,2mm	50640 01	31,16
50,7 - 100,7mm	50658 11	95,17
"	"	"
105,3 - 150,3mm	50658 21	121,23

Sleufmatrijs	Art.nr.	Prijs
5,3x10,3 - 12x16mm	50633 03	17,45
5,3x20,3 - 26,5x31mm	50638 03	23,79
11,3x35,3 - 28x41mm	50639 03	32,74
11,3x45,3 - 28x51mm	50640 03	50,99

Matrijs vierkant	Art.nr.	Prijs
4,2 - 11,2 mm	50633 02	13,37
11,7 - 22,2mm	50638 02	20,73
21,7 - 29,2mm	50639 02	29,23
28,7 - 35,7mm	50640 03	41,69
40,3 - 70,3mm	50658 12	220,94

Stempels Ø20 tbv handponsmachines

Stempel typ Ø20	Art.nr.	Prijs
3 -20 mm (rond)	50519-11	12,60
3 -14 mm (vkt)	50519-12	15,75

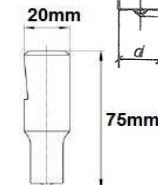

Stempels & matrijzen tbv hand-
ponsmachines, o.a. Mubea 23N/10
(- Stempel Ø15, L=38mm)
(- Matrijs rechthoek 30x45x12mm)
(- Matrijs ronde uitvoering Ø20mm)

Stemp. Ø10	Art.nr.	Prijs
2-10mm	50512-1	14,65
10.5-13mm	50512-2	18,32
Matr.30x45	Art.nr.	Prijs
2.2-10.7mm	50613-1	36,80
11.2-13.2mm	50613-2	38,40
Matr. Ø20	Art.nr.	Prijs
2.2-10.7mm	50631-01	15,30

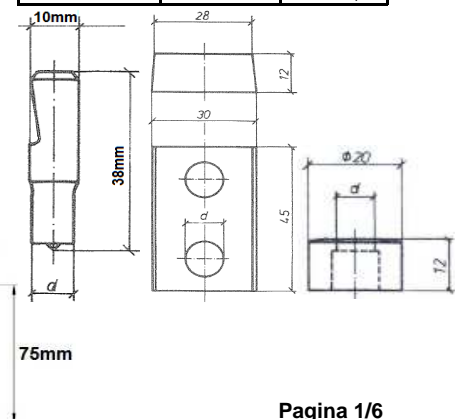

GEKA

[\(zie ook bijlage 1 op pag. 4 t.b.v. bepaling juiste type stempel & matrijs\)](#)

GEKA stempel (rond - sleufgat)

GEKA type	Ref. OUD /	Prijs rond	Prijs sleuf	Prijs vkt
no. 1	50991 - 1	9,27	28,51	27,37
no. 2	50599 - 2	9,27	28,51	27,37
no. 5 - 15	50556 - 1	5,94	28,51	24,99
no. 5 - 27 (NW)	50599 - 9	8,32	30,89	29,75
no. 6	50599 - 6	10,69	36,23	33,32
no. 8 - 19	50556 - 2	7,72	29,16	30,94
no. 8 - 31 (NW)	50599 - 7	11,29	30,89	29,16
no. 8 - 40 (NW)	50599 - 8	20,91	38,02	35,70
no. 10 - 26	50556 - 3	11,76	34,45	35,11
no. 11 - 40	50599 - 0	25,54	44,55	39,87
no. 11 (NW)	50599 - 3	34,45	53,46	51,77
no. 11A	50599 - 35	38,02	62,96	51,17
no. 12 (NW)	50599 - 4	58,21	92,66	92,81
no. 12 A	59599 - 45	58,21	96,23	96,38
no. 13 (NW)	50599 - 5	87,91	121,18	114,23
no. 13 A	59599 - 55	97,42	123,55	114,23

NW *: betreft maatserie met nwe artikelnrs v.a. 15-04-16 (opgenomen in nwe catalogus)

Peddinghaus

[\(zie ook bijlage 2 op pag. 5 t.b.v. bepaling juiste type stempel & matrijs\)](#)

Peddinghaus stempel

Peddinghaus type	Ref. Mub.	Prijs rond	Prijs sleuf	Prijs vkt
no. 1 (rode serie)	50556 - 1	5,94	28,51	24,98
no. 2 (groene serie)	50556 - 2	7,72	29,70	30,94
no. 3 (blauwe serie)	50556 - 3	11,76	34,45	35,11
no. 4 (rode serie)	50556 - 4	8,32	30,89	29,75
no. 5 (groene serie)	50556 - 5	11,29	30,89	29,16
no. 6 (blauwe serie)	50556-6	25,54	44,55	39,87
no. 7 (blauwe serie)	50556-7	41,58	68,31	68,43
55: zie Mubea 50516-1	50516	10,97	25,74	18,75
56	50516	Beperkt leverbaar NTB		

GEKA matrijs (rond - sleufgat)

GEKA type	Ref. Mubea	Prijs rond	Prijs sleuf	Prijs vkt
no. 1	50695 - 1	10,10	29,70	32,73
no. 1A	50695 - 5	11,40	24,95	25,59
no. 2	50695 - 2	11,29	24,95	25,59
no. 5 (NW)	50695 - 6	10,10	28,51	32,13
no. 6	50673 - 2	8,91	27,32	35,11
no. 8 (NW)	50695 - 8	14,61	32,67	38,08
no. 10	50695 - 3	29,70	54,65	47,01
no. 11 (NW)	50695 - 4	29,70	55,84	45,22
no. 12 (NW)	50695 - 7	58,21	93,26	92,81
no. 13 (NW)	50695 - 9	68,90	143,75	114,23

NW *: betreft maatserie met nwe artikelnrs v.a. 15-04-16 (opgenomen in nwe catalogus)

Peddinghaus matrijs

Pedd. type	Ref. Mubea	Prijs rond	Prijs sleuf	Prijs vkt
no. 2 (rd)	50673 - 2	8,91	27,32	35,11
no. 3 (grn)	50673 - 3	10,10	28,51	32,13
no. 4 (bl)	50673 - 4	17,82	46,33	46,41
no. 6 (bl)	50673 - 6	34,45	59,40	78,53
no. 7 (bl)	50675 - 7	25,54	special	special
no. 8	50675 - 8	29,11	special	special
no. 13 (rd)	50674 - 13	14,26	42,77	special
no. 14 (grn)	50674 - 14	17,82	46,33	special
no. 20 (bl)	50673 - 7	105,73	special	special
no. 57 **	50635	11,20	special	special

** Alternatief: matrijshouder art. 81204 + MBN 50633 01 matrijzen.

KINGSLAND

[\(zie ook bijlage 3 op pag. 6 t.b.v. bepaling juiste type stempel & matrijs\)](#)

Kingsland stempel

Kingsland rnd/slf/vkt	Ref. Mub.	Prijs rond	Prijs sleuf	Prijs vkt
K9000 / / K9000	50582 - 1...	8,19	<i>special</i>	28,08
K9001 / K9184 / K9171	50556 - 5...	12,87	32,76	29,25
K9004 / K9185 / K9172	50582 - 3...	19,85	39,20	42,12
K9006 / K9187	50582 - 4...	25,74	44,46	<i>special</i>
K9007 / K9188	50582 - 5...	46,80	69,03	<i>special</i>
K9009 / K9190	50582 - 6...	59,67	<i>special</i>	<i>special</i>
K9010 / K9191	50582 - 7...	69,03	<i>special</i>	<i>special</i>
K9011 / K9192	50582 - 8...	95,94	167,31	<i>special</i>

Kingsland matrijs

Kingsland rnd/slf/vkt	Ref. Mubea	Prijs rond	Prijs sleuf	Prijs vkt
K9020 / ... / K9020	50696 - 1...	10,53	<i>special</i>	22,82
K9023 / K9221 / K9213	50696 - 2...	22,23	42,12	49,14
K9024 / K9222	50696 - 3...	53,82	79,56	<i>special</i>
K9025 / K9223	50696 - 4...	65,52	<i>special</i>	<i>special</i>
K9026 / K9224	50696 - 5...	94,77	155,61	<i>special</i>

BESTEN MACHINES, UW DEALER VAN:

**** NARGESA PLAATBEWERKING-, MUBEA PONSKNIP- & PILOUS ZAAGMACHINES!***

VERKOOP NIEUWE EN GEBRUIKTE MACHINES, REVISIE & REPARATIE, NEN 3140-KEURING & ONDERHOUD:

- Guillotinescharen
- Kantbanken
- Pons-knip machines
- Draaibanken
- Freesmachines
- Zaagmachines (metaal en hout)
- Bandschuurmachines, pijpuitslijpers
- Lintzagen & schuurbanden
- Rollenbaan (standaard & maatwerk)
- Kolomboormachines
- Profielwalsen
- Lasapparaten & toebehoren
- Plasmasnijders
- Compressoren & toebehoren
- Werkplaatspersen & werkplaatsinrichting
- Handgereedschappen
- Buigblokken, spantangen, etc. etc.
- Topkwaliteit slijpschijven Globe
- LENGTEMEETSISTEMEN tbv zaag-/ponsknipmachines etc.
- X-Y-coördinatentafel besturingen tbv uw ponsknipmachine.



BIJLAGE 1: Maatvoeringstabellen stempels en matrijzen GEKA & MUBEA opname

GEKA

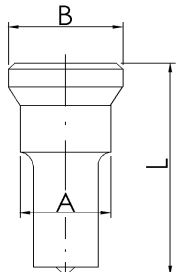
Stempel/pons	Ref. GEKA	Ref. Mub.	Ø A mm	Ø B mm	L mm	
	1	50 599 - 1	20,0	24,0	41,0	
	2	50 599 - 2	26,0	30,0	41,0	
	5 - 15	50 556 - 1	14,4	19,2	53,0	
	5 - 27	50 599 - 9	26,4	30,5	53,0	NW *
	6	50 599 - 6	28,0	31,5	58,0	
	8 - 19	50 556 - 2	19,2	25,4	64,0	
	8 - 31	50 599 - 7	31,0	35,5	64,0	NW *
	8 - 40	50 599 - 8	40,0	43,5	64,0	NW *
	10 - 26	50 556 - 3	26,4	29,5	73,0	
	10 - 40	50 599 - 0	40,0	43,5	73,0	
	11	50 599 - 3	50,0	54,0	58,0	NW *
	12	50 599 - 4	75,0	79,0	58,0	NW *
	13	50 599 - 5	100,0	104,0	58,0	NW *
	14	50 599 -	50,0	54,0	73,0	
	15	50 599 -	75,0	79,0	73,0	
	16	50 599 -	100,0	104,0	73,0	

NW *: betreft maatserie met nwe artikelnrs v.a. 15-04-16 (opgenomen in nwe catalogus)

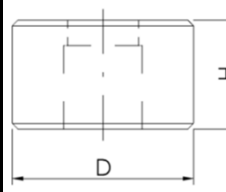
Matrijzen	Ref. GEKA	Ref.	Ø D mm	H mm	
	1	50 635	35,0	17,0	
	1A	50 695 - 5	38,0	22,0	
	2	50 695 - 2	43,0	17,0	
	5	50 695 - 6	50,8	25,4	NW *
	6	50 673 - 2	46,0	28,6	
	8	50 695 - 8	60,0	32,0	NW *
	10	50 695 - 3	73,0	32,0	
	11	50 695 - 4	78,0	28,5	NW *
	12	50 695 - 7	100,0	28,5	NW *
	13	50 695 - 9	125,0	28,5	NW *

NW *: betreft maatserie met nwe artikelnrs v.a. 15-04-16 (opgenomen in nwe catalogus)

Mubea

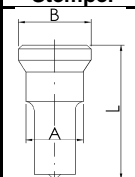
Stempel	Ref. Mub.	Ø A mm	Ø B mm	L mm
	50505-1	15,0	20,0	38,0
	50505-2	30,0	36,0	70,0
	50505-3	40,0	46,0	70,0
	50505-4	50,0	56,0	70,0

OUDE TYPE + HANDPONSEN

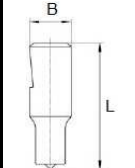
	Ref. Mub.	Ø A mm	Ø B mm	L mm
	50516 11	(rond)	15,0	15,0
50516 12	(vierkant)	15,0	15,0	55,0
50516 13	(sleufgat)	15,0	15,0	55,0
50519-11	(rond)	20,0	20,0	75,0
50519-12	(vierkant)	20,0	20,0	75,0

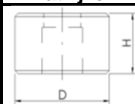
Matrijzen	Ref.	Ø D mm	H mm
	50633	30,0	15,0
	50638	45,0	22,5
	50639	60,0	30,0
	50640	80,0	40,0

BIJLAGE 2: Maatvoeringstabellen stempels en matrijzen Peddinghaus

Peddinghaus

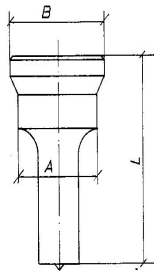
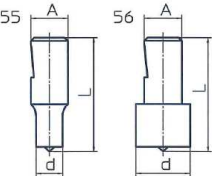
Stempel/pons	Ref. PFP	Ref. Mub.	Ø A mm	Ø B mm	L mm
	1	50 556 - 1	14,4	19,2	49,2
	2	50 556 - 2	19,2	25,4	61,0
	3	50 556 - 3	26,4	30,5	72,0
	4	50 556 - 4	26,4	30,5	49,2
	4	50 556 - 4	30,0	31,5	49,2 ^{*2}
	5	50 556 - 5	31,5	35,5	60,3
	6	50 556 - 6	39,5	43,5	72,0
	7	50 556 - 7	58,5	65,0	72,0
	7,1	50 556 - 7	58,5	65,0	72,0 ^{*1}
	11	50 556 - 8	90,0	94,5	76,2
	12	50 556 - 8	90,0	94,5	76,2 ^{*1}
		55 *	50 516 - 1	15,0	d = 3 - 15
56 **		50 516 - 2	15,0	d = 15,5-22	55,0
<p>* Peddinghaus nr.55 is gelijk aan Mubea MBN 50516 ** Peddinghaus nr.56 is niet meer leverbaar</p>					

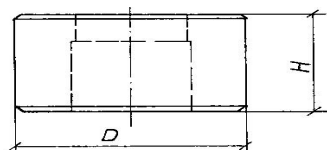
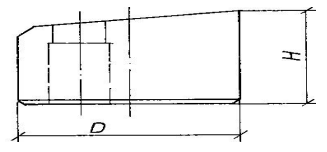
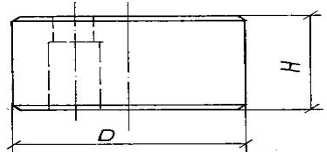
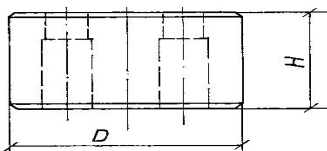
Matrijzen	Ref. PFP	Ref. Mub.	Ø D mm	H mm
	2	50 673 - 2	46,04	28,6
	3	50 673 - 3	50,8	25,4
	4	50 673 - 4	63,5	31,7
	6	50 673 - 6	90,0	31,7
	20	50 673 - 7	140,0	31,7
	57**	50 635	35,0	17,0
	<p>** Nr.57 Beperkt op voorraad. Alternatief: matrijshouder art.81204 + Mubea matrijzen</p>			
	7	50 675 - 7	46,0	27,5 / 32,5
	8	50 675 - 8	50,8	24,5 / 30,0
	13	50 674 - 13	46,04	28,6
	14	50 674 - 14	50,8	25,4
	16	50 676 - 16	46,04	28,6
	17	50 676 - 17	50,8	25,4

BIJLAGE 3 Maatvoeringstabellen stempels en matrijzen Kingsland



Stempel/pons	Ref. Kingsland			Ref. Mub.	Ø A	Ø B	L	Ø d	
	K9000			50 582 - 1	19,2	25,4	61,3	3 - 19	mm
	K9001	K9171	K9184	50 556 - 5	30,9	35,0	60,3	3 - 30	mm
	K9004	K9172	K9185	50 582 - 3	38,0	44,0	60,3	3 - 38	mm
	K9006	K9174	K9187	50 582 - 4	39,5	44,0	76,2	4 - 38	mm
	K9007	K9175	K9188	50 582 - 5	57,0	62,5	63,3	39 - 57	mm
	K9009	K9177	K9190	50 582 - 6	57,0	62,5	76,7	39 - 57	mm
	K9010	K9178	K9191	50 582 - 7	85,0	92,0	70,5	58 - 85	mm
	K9011	K9179	K9192	50 582 - 8	110,0	117,0	72,5	86 - 110	mm

Matrijzen	Ref. Kingsland			Ref. Mub.	Ø D	H	Ø d	
	K9020			50 696 - 1	31,7	19,0	3 - 19	mm
	K9023	K9213	K9221	50 696 - 2	60,3	32,0	3 - 38	mm
	K9024	K9214	K9222	50 696 - 3	93,5	32,0	39 - 57	mm
	K9025	K9215	K9223	50 696 - 4	115,0	32,0	58 - 85	mm
	K9026	K9216	K9224	50 696 - 5	140,0	32,0	86 - 110	mm

* **BESTELLIJST PAG. 1/2 TBV STEPELS & MATRIJZEN: MUBEA TYPE OPNAME (niet tbv GEKA Pedd. etc) ***

Stempel rond mm	MBN 50505-1 Artikel-Nr.	Bestellmenge Order quantity Quantité d'ordre	Matrizen rond mm	MBN 50633 Artikel-Nr.	Bestellmenge Order quantity Quantité d'ordre	Stempel langloch bxl mm	MBN 50505-2 Artikel-Nr.	Bestellmenge Order quantity Quantité d'ordre
3.0	50505 11 008		3,20	50633 01 009		5,0 x 10,0	50505 23 001	
3.5	50505 11 011		3,70	50633 01 012		5,0 x 13,0	50505 23 002	
4.0	50505 11 013		4,20	50633 01 014		5,0 x 15,0	50505 23 003	
4.5	50505 11 015		4,70	50633 01 016		5,0 x 20,0	50505 23 004	
5.0	50505 11 017		5,20	50633 01 018		5,0 x 25,0	50505 23 005	
5.5	50505 11 019		5,70	50633 01 021		5,5 x 11,0	50505 23 019	
6.0	50505 11 022		6,20	50633 01 023		5,5 x 13,0	50505 23 020	
6.5	50505 11 024		6,70	50633 01 025		5,5 x 15,0	50505 23 021	
7.0	50505 11 026		7,20	50633 01 027		5,5 x 20,0	50505 23 022	
7.5	50505 11 028		7,70	50633 01 029		5,5 x 25,0	50505 23 023	
8.0	50505 11 031		8,20	50633 01 032		6,5 x 13,0	50505 23 037	
8.5	50505 11 033		8,70	50633 01 034		6,5 x 15,0	50505 23 038	
9.0	50505 11 035		9,20	50633 01 036		6,5 x 20,0	50505 23 039	
9.5	50505 11 037		9,70	50633 01 038		6,5 x 25,0	50505 23 040	
10.0	50505 11 039		10,20	50633 01 041		7,0 x 30,0	50505 23 041	
10.5	50505 11 042		10,70	50633 01 043		7,0 x 15,0	50505 23 055	
11.0	50505 11 044		11,20	50633 01 045		7,0 x 20,0	50505 23 066	
11.5	50505 11 046		11,70	50633 01 047		7,0 x 25,0	50505 23 057	
12.0	50505 11 048		12,20	50633 01 049		7,0 x 30,0	50505 23 058	
12.5	50505 11 051		12,70	50633 01 052		8,0 x 13,0	50505 23 070	
13.0	50505 11 053		13,20	50633 01 054		8,0 x 16,0	50505 23 071	
13.5	50505 11 055		13,70	50633 01 056		8,0 x 20,0	50505 23 072	
14.0	50505 11 057		14,20	50633 01 058		8,0 x 25,0	50505 23 073	
14.5	50505 11 059		14,70	50633 01 061		8,0 x 30,0	50505 23 074	
15.0	50505 11 062		15,20	50633 01 063		9,0 x 13,0	50505 23 088	
			15,70	50633 01 065		9,0 x 18,0	50505 23 089	
			16,20	50633 01 067		9,0 x 20,0	50505 23 090	
Stempel rond mm	MBN 50505-2 Artikel-Nr.	Bestellmenge Order quantity Quantité d'ordre	Matrizen rond mm	MBN 50638 Artikel-Nr.	Bestellmenge Order quantity Quantité d'ordre			
15.5	50505 21 064		15,70	50638 01 065		9,0 x 25,0	50505 23 091	
16.0	50505 21 066		16,20	50638 01 067		9,5 x 13,0	50505 23 092	
16.5	50505 21 068		16,70	50638 01 069		9,5 x 15,0	50505 23 108	
17.0	50505 21 071		17,20	50638 01 072		9,5 x 20,0	50505 23 109	
17.5	50505 21 073		17,70	50638 01 074		9,5 x 25,0	50505 23 110	
18.0	50505 21 075		18,20	50638 01 076		10,5 x 15,0	50505 23 111	
18.5	50505 21 077		18,70	50638 01 078		10,5 x 20,0	50505 23 125	
19.0	50505 21 079		19,20	50638 01 081		10,5 x 25,0	50505 23 126	
19.5	50505 21 082		19,70	50638 01 083		10,5 x 30,0	50505 23 127	
20.0	50505 21 084		20,20	50638 01 085		11,0 x 15,0	50505 23 128	
20.5	50505 21 086		20,70	50638 01 087		11,0 x 20,0	50505 23 141	
21.0	50505 21 088		21,20	50638 01 089		11,0 x 25,0	50505 23 142	
21.5	50505 21 091		21,70	50638 01 092		11,0 x 30,0	50505 23 143	
22.0	50505 21 093		22,20	50638 01 094		12,0 x 20,0	50505 23 167	
22.5	50505 21 095		22,70	50638 01 096		12,0 x 25,0	50505 23 168	
23.0	50505 21 097		23,20	50638 01 098		12,0 x 30,0	50505 23 169	
23.5	50505 21 099		23,70	50638 01 101		13,0 x 20,0	50505 23 179	
24.0	50505 21 102		24,20	50638 01 103		13,0 x 25,0	50505 23 180	
24.5	50505 21 104		24,70	50638 01 105		13,0 x 30,0	50505 23 181	
25.0	50505 21 106		25,20	50638 01 107		13,5 x 20,0	50505 23 191	
25.5	50505 21 108		25,70	50638 01 109		13,5 x 25,0	50505 23 192	
26.0	50505 21 111		26,20	50638 01 112		13,5 x 30,0	50505 23 193	
26.5	50505 21 113		26,70	50638 01 114		14,0 x 20,0	50505 23 215	
27.0	50505 21 115		27,20	50638 01 116		14,0 x 25,0	50505 23 216	
27.5	50505 21 117		27,70	50638 01 118		14,0 x 30,0	50505 23 217	
28.0	50505 21 119		28,20	50638 01 121		16,0 x 25,0	50505 23 233	
28.5	50505 21 122		28,70	50638 01 123		16,0 x 30,0	50505 23 234	
29.0	50505 21 124		29,20	50638 01 125		17,5 x 25,0	50505 23 248	
29.5	50505 21 126		29,70	50638 01 127		17,5 x 30,0	50505 23 249	
30.0	50505 21 128		30,20	50638 01 129		18,0 x 30,0	50505 23 255	
			30,70	50638 01 132		19,0 x 25,0	50505 23 266	
			31,20	50638 01 134		19,0 x 30,0	50505 23 267	
			31,70	50638 01 136		20,5 x 25,0	50505 23 281	
						20,5 x 30,0	50505 23 282	
						22,0 x 30,0	50505 23 288	
						22,5 x 30,0	50505 23 301	
						24,0 x 30,0	50505 23 316	
						25,5 x 30,0	50505 23 328	

* **BESTELLIJST PAG. 2/2 TBV STEPELS & MATRIJZEN: MUBEA TYPE OPNAME (niet tbv GEKA Pedd. etc) ***

Matrizen langlooch bxl mm	MBN 50633 Artikel-Nr.	Bestellmenge Order quantity Quantité d'ordre	Matrizen langlooch bxl mm	MBN 50638 Artikel-Nr.	Bestellmenge Order quantity Quantité d'ordre	Matrizen langlooch bxl mm	MBN 50638 Artikel-Nr.	Bestellmenge Order quantity Quantité d'ordre
5.3 x 10.3	50633 03 007		10.0 x 19.0	50638 03 102		26.5 x 31.0	50638 03 336	
5.3 x 13.3	50633 03 008		10.0 x 21.0	50638 03 103				
5.3 x 15.3	50633 03 009		10.0 x 26.0	50638 03 104				
5.8 x 11.3	50633 03 025		10.0 x 31.0	50638 03 105				
5.8 x 13.3	50633 03 026		10.5 x 21.0	50638 03 126				
5.8 x 15.3	50633 03 027		10.5 x 26.0	50638 03 122				
6.0 x 11.0	50633 03 013		10.5 x 31.0	50638 03 123				
6.0 x 14.0	50633 03 014		10.8 x 21.3	50638 03 131				
6.0 x 16.0	50633 03 015		10.8 x 25.3	50638 03 132				
6.5 x 12.0	50633 03 031		10.8 x 30.3	50638 03 133				
6.5 x 14.0	50633 03 032		11.3 x 20.3	50638 03 150				
6.5 x 16.0	50633 03 033		11.3 x 25.3	50638 03 151				
6.8 x 13.3	50633 03 043		11.3 x 30.3	50638 03 152				
6.8 x 15.3	50633 03 044		11.5 x 22.0	50638 03 136				
7.3 x 15.3	50633 03 060		11.5 x 26.0	50638 03 137				
7.5 x 14.0	50633 03 049		11.5 x 31.0	50638 03 138				
7.5 x 16.0	50633 03 050		12.0 x 21.0	50638 03 159				
8.0 x 16.0	50633 03 071		12.0 x 26.0	50638 03 160				
8.3 x 13.3	50633 03 076		12.0 x 31.0	50638 03 161				
9.0 x 14.0	50633 03 082		12.3 x 20.3	50638 03 171				
9.3 x 13.3	50633 03 094		12.3 x 25.3	50638 03 172				
9.8 x 13.3	50633 03 113		12.3 x 30.3	50638 03 173				
9.8 x 15.3	50633 03 114		13.0 x 21.0	50638 03 175				
10.0 x 14.0	50633 03 101		13.0 x 26.0	50638 03 176				
10.5 x 14.0	50633 03 119		13.0 x 31.0	50638 03 177				
10.5 x 16.0	50633 03 120		13.3 x 20.3	50638 03 183				
10.8 x 15.3	50633 03 130		13.3 x 25.3	50638 03 184				
11.3 x 15.3	50633 03 149		13.3 x 30.3	50638 03 185				
11.5 x 16.0	50633 03 135		13.8 x 20.3	50638 03 201				
12.0 x 16.0	50633 03 158		13.8 x 25.3	50638 03 202				
Matrizen langlooch bxl mm	MBN 50638 Artikel-Nr.	Bestellmenge Order quantity Quantité d'ordre	Matrizen langlooch bxl mm	MBN 50638 Artikel-Nr.	Bestellmenge Order quantity Quantité d'ordre	Matrizen langlooch bxl mm	MBN 50638 Artikel-Nr.	Bestellmenge Order quantity Quantité d'ordre
5.3 x 20.3	50638 03 010		14.0 x 31.0	50638 03 189				
5.3 x 25.3	50638 03 011		14.3 x 20.3	50638 03 221				
5.8 x 20.3	50638 03 028		14.3 x 25.3	50638 03 222				
5.8 x 25.3	50638 03 029		14.3 x 30.3	50638 03 223				
6.0 x 21.0	50638 03 016		14.5 x 21.0	50638 03 208				
6.0 x 26.0	50638 03 017		14.5 x 26.0	50638 03 209				
6.5 x 21.0	50638 03 034		14.5 x 31.0	50638 03 210				
6.5 x 26.0	50638 03 035		15.0 x 21.0	50638 03 227				
6.8 x 20.3	50638 03 045		15.0 x 26.0	50638 03 228				
6.8 x 25.3	50638 03 046		15.0 x 31.0	50638 03 229				
6.8 x 30.3	50638 03 047		16.3 x 25.3	50638 03 238				
7.3 x 20.3	50638 03 061		16.3 x 30.3	50638 03 239				
7.3 x 25.3	50638 03 062		17.0 x 26.0	50638 03 243				
7.3 x 30.3	50638 03 063		17.0 x 31.0	50638 03 244				
7.5 x 21.0	50638 03 051		17.8 x 25.3	50638 03 254				
7.5 x 26.0	50638 03 052		17.8 x 30.3	50638 03 255				
7.5 x 31.0	50638 03 053		18.3 x 30.3	50638 03 258				
8.0 x 21.0	50638 03 066		18.5 x 26.0	50638 03 260				
8.0 x 26.0	50638 03 067		18.5 x 31.0	50638 03 261				
8.0 x 31.0	50638 03 068		19.0 x 31.0	50638 03 264				
8.3 x 16.3	50638 03 077		19.3 x 25.3	50638 03 271				
8.3 x 20.3	50638 03 078		19.3 x 30.3	50638 03 272				
8.3 x 25.3	50638 03 079		20.0 x 26.0	50638 03 276				
8.3 x 30.3	50638 03 080		20.0 x 31.0	50638 03 277				
9.0 x 17.0	50638 03 083		20.8 x 25.3	50638 03 287				
9.0 x 21.0	50638 03 084		20.8 x 30.3	50638 03 288				
9.0 x 26.0	50638 03 085		21.5 x 26.0	50638 03 293				
9.0 x 31.0	50638 03 086		21.5 x 31.0	50638 03 294				
9.3 x 18.3	50638 03 095		22.3 x 30.3	50638 03 295				
9.3 x 20.3	50638 03 096		22.8 x 30.3	50638 03 306				
9.3 x 25.3	50638 03 097		23.0 x 31.0	50638 03 308				
9.3 x 30.3	50638 03 098		23.5 x 31.0	50638 03 311				
9.8 x 20.3	50638 03 115		24.3 x 30.3	50638 03 320				
9.8 x 25.3	50638 03 116		25.0 x 31.0	50638 03 324				
9.8 x 30.3	50638 03 117		25.8 x 30.3	50638 03 332				

PRIJSLIJST SPECIALE STEMPELS & MATRIJZEN TBV MUBEA:

* Special: betreft afwijkende PONGGATMATEN, naar keuze tot op 0,1mm (bijv. stempel 12.1mm in mt.2)

* Tevens meerdere speciale bewerkingen mogelijk, hieronder prijsindicaties (obv std prijzen pagina 1):

- T/m mt.3: Meerprijs: naslijpen tbv exacte maatvoering: basisprijs x 2.2

- T/m mt.3: Meerprijs: extra harde 'SS-uitvoering: basisprijs x 2.0

- T/m mt.3: Meerprijs: langere uitvoering: basisprijs x 3.6

- T/m mt.3: Meerprijs: naslijpen + harde 'SS-uitvoering': basisprijs x 3.6

Mubea

[\(zie ook bijlage 1 op pag. 4 t.b.v. bepaling juiste type stempel & matrijs\)](#)

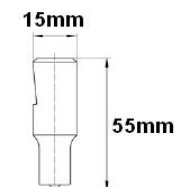

Mubea stempel

Rond	Art.nr. mt. 1,2,3,4etc	Prijs
3 - 15mm	505051-SP	22,49
3 - 30mm	505052-SP	32,14
3 - 40mm	505053-SP	59,15
3 - 50mm	505054-SP	86,91
3 - 70mm	505851-SP	214,20
3 - 100mm	505852-SP	252,45
3 - 150mm	505853-SP	318,37

Sleufgatstempel	Art.nr. mt. 1,2,3,4etc	Prijs
5x10 - 25.5x30mm	5050523-SF	59,20
5x10 - 27x40mm	5050533-SF	74,10
5x10 - 27x50mm	5050543-SF	132,40
5x10 - 27x70mm	5058513-SF	209,50

Stempel vierkant	Art.nr. mt. 1,2,3,4etc	Prijs
4 - 21mm	5050522-SF	54,23
4 - 28mm	5050532-SF	75,45
4 - 35mm	5050542-SF	104,15
4 - 50mm	5058612-SF	275,40
4 - 60mm	5058622-SF	309,83
4 - 70mm	5058632-SF	412,40

Stempel rechthoek	Art.nr. mt. 1,2,3,4etc	Prijs
4 - 21mm	505052-SP	59,20
4 - 28mm	505053-SP	81,30
4 - 35mm	505054-SP	108,80
4 - 50mm	505861-SP	281,60
4 - 60mm	505862-SP	340,10
4 - 70mm	505863-SP	421,20

Mubea matrijs

Rond	Art.nr. mt. 1,2,3,4 etc	Prijs
3,2 - 15,7mm	50633-SPEC-RND-DIA	27,39
3,2 - 31,2mm	50638-SPEC-RND-DIA	36,43
3,2 - 41,2mm	50639-SPEC-RND-DIA	59,02
3,2 - 51,2mm	50640-SPEC-RND-DIA	87,35
3,2 - 100,7mm	506581-SPEC-RND-DIA	245,40
3,2 - 150,3mm	506582-SPEC-RND-DIA	319,00

Sleufmatrijs	Art.nr. (mt. 1,2,3,4 etc)	Prijs
5,3x10,3 - 12x16mm	5063303-SPEC-SLF-DIA	58,91
5,3x10,3 - 26,5x31mm	5063803-SPEC-SLF-DIA	63,85
5,3x10,3 - 28x41mm	5063903-SPEC-SLF-DIA	76,50
5,3x10,3 - 28x51mm	5064003-SPEC-SLF-DIA	123,60
5,3x10,3 - 28x71mm	5058513-SPEC-SLF-DIA	196,75

Matrijs vierkant	Art.nr. (mt. 1,2,3,4 etc)	Prijs
4,2 - 11,2mm	5063302-SPEC-VKT-DIA	46,32
4,2 - 22,2mm	5063802-SPEC-VKT-DIA	56,50
4,2 - 29,2mm	5063902-SPEC-VKT-DIA	77,42
4,2 - 35,7mm	5064003-SPEC-VKT-DIA	101,53
4,2 - 70,3mm	5065812-SPEC-VKT-DIA	422,40

Matrijs rechthoek	Art.nr. (mt. 1,2,3,4 etc)	Prijs
4,2 - 11,2mm	50633-SPEC-RH-DIA	54,20
4,2 - 22,2mm	50638-SPEC-RH-DIA	63,50
4,2 - 29,2mm	50639-SPEC-RH-DIA	86,00
4,2 - 35,7mm	50640-SPEC-RH-DIA	111,30
4,2 - 70,3mm	50658-SPEC-RH-DIA	429,40

Oude opname: gelijk aan Peddinghaus nr.55

Stempel type	Art.nr.	Prijs
3 -15 (rnd)	50516 11	24,30
15.5 -20(rnd)	50516 21	39,14
4 -10.5 (vkt)	50516 12	38,40
5x10-11x15 (sl)	50516 13	56,23

Oude opname: gelijk aan Peddinghaus nr.55

Stempel type	Art.nr.	Prijs
3-15 (rnd) SS	5051611-SL	41,47
15.5-22 (rnd) SS	5051621-SL	52,30
.....		op aanv.

=> Betreft nageslepen tbv nauwkeurigheid tot 0,01mm & extra gehard (uitvoering "SS")

SPECIALE STEPELS & MATRIJZEN TBV MUBEA (langere uitvoering, max. 100mm)

* Special: betreft afwijkende LENGTE STEPELS

* Mogelijkheden, bijv.: stempel rond TOTALE LENGTE 90MM ipv L=70mm maatvoering 2 (kopmaat 36mm, halsmaat 30mm)

Mubea

[\(zie ook bijlage 1 op pag. 4 t.b.v. bepaling juiste type stempel & matrijs\)](#)

Mubea stempel

Rond	Alg. art.nr. tbv mt. 1,2,3,4etc *
Stempel mt.1: rond	505051-SPEC-RND-LNG
Stempel mt.2: rond	505052-SPEC-RND-LNG
Stempel mt.3: rond	505053-SPEC-RND-LNG
Stempel mt.4: rond	505054-SPEC-RND-LNG
Sleufgatstempel	
Alg. art.nr. tbv mt. 2,3,4 *	
Stempel maat 2: sleuf	5050523-SPEC-SLF-LNG
Stempel maat 3: sleuf	5050533-SPEC-SLF-LNG
Stempel maat 4: sleuf	5050543-SPEC-SLF-LNG
Stempel vierkant	
Alg. art.nr. tbv mt. 2,3,4 *	
4 - 21mm	5050522-SPEC-VKT-LNG
4 - 28mm	5050532-SPEC-VKT-LNG
4 - 35mm	5050542-SPEC-VKT-LNG
Stempel rechthoek	
Alg. art.nr. tbv mt. 2,3,4 *	
4 - 21mm	505052-SPEC-RH-LNG
4 - 28mm	505053-SPEC-RH-LNG
4 - 35mm	505054-SPEC-RH-LNG

(tot max. lengte 100mm, afwijkende lengtes ook mogelijk op aanvraag)
 (tot max. lengte 100mm, afwijkende lengtes ook mogelijk op aanvraag)
 (tot max. lengte 100mm, afwijkende lengtes ook mogelijk op aanvraag)
 (tot max. lengte 100mm, afwijkende lengtes ook mogelijk op aanvraag)

(tot max. lengte 100mm, afwijkende lengtes ook mogelijk op aanvraag)
 (tot max. lengte 100mm, afwijkende lengtes ook mogelijk op aanvraag)
 (tot max. lengte 100mm, afwijkende lengtes ook mogelijk op aanvraag)

(tot max. lengte 100mm, afwijkende lengtes ook mogelijk op aanvraag)
 (tot max. lengte 100mm, afwijkende lengtes ook mogelijk op aanvraag)
 (tot max. lengte 100mm, afwijkende lengtes ook mogelijk op aanvraag)

(tot max. lengte 100mm, afwijkende lengtes ook mogelijk op aanvraag)
 (tot max. lengte 100mm, afwijkende lengtes ook mogelijk op aanvraag)
 (tot max. lengte 100mm, afwijkende lengtes ook mogelijk op aanvraag)

PRIJSLIJST SPECIALE STEMPELS & MATRIJZEN TBV GEKA & PEDDINGHAUS

GEKA

[\(zie ook bijlage 1 op pag. 4 t.b.v. bepaling juiste type stempel & matrijs\)](#)

GEKA stempel (rond - sleufgat)

GEKA type	Ref. Mub.	Rond	Slf/Rechth	Vierkant
no. 1	50991-1	23,73	57,02	54,74
no. 2	50599-2	23,73	57,02	54,74
no. 5 - 15	50556-1	15,21	57,02	49,98
no. 5 - 27	50556-4	21,30	61,78	59,50
no. 6	50599-6	27,37	72,46	66,64
no. 8 - 19	50556-2	19,76	58,32	61,88
no. 8 - 31	50556-5	28,90	61,78	58,32
no. 8 - 40	50599-8	53,53	76,04	71,40
no. 10 - 26	50556-3	30,11	68,90	70,22
no. 11 - 40	50599-0	65,38	89,10	79,74
no. 11	50599-3	88,19	106,92	103,54
no. 11A	50599-35	97,33	125,92	102,34
no. 12	59599-4	149,02	185,32	185,62
no. 12 A	59599-45	149,02	192,49	192,76
no. 13	59599-5	225,05	242,36	228,46
no. 13 A	59599-55	249,40	247,10	228,46

GEKA matrijs (rond - sleufgat)

GEKA type	Ref. Mubea	Rond	Slf/Rechth	Vierkant
no. 1	50695 - 1	25,86	65,34	72,01
no. 1A	50695 - 5	29,18	54,89	56,30
no. 2	50695 - 2	28,90	54,89	56,30
no. 5	50673 - 3	25,86	62,73	70,69
no. 6	50673 - 2	22,81	60,11	77,24
no. 8	50695 - 8	37,40	71,87	83,78
no. 10	50695 - 3	76,03	120,23	103,42
no. 11	50695 - 4	76,03	122,84	99,48
no. 12	50695 - 7	149,02	205,17	204,18
no. 13	50695 - 9	176,38	316,25	251,31

Peddinghaus

[\(zie ook bijlage 2 op pag. 5 t.b.v. bepaling juiste type stempel & matrijs\)](#)

Peddinghaus stempel

Peddinghaus type	Ref. Mub.	Rond	Slf/Rechth	Vierkant
no. 1 (rode serie)	50556-1	15,21	57,02	49,98
no. 2 (groene serie)	50556-2	19,76	58,32	61,88
no. 3 (blauwe serie)	50556-3	30,11	68,90	70,22
no. 4 (rode serie)	50556-4	21,30	61,78	59,50
no. 5 (groene serie)	50556-5	28,90	61,78	58,32
no. 6 (blauwe serie)	50556-6	65,39	89,10	79,74
no. 7 (blauwe serie)	50556-7	106,44	136,62	136,86
55: zie Mubea 50516-1	50516	28,08	51,48	37,50
56	50516	<i>Beperkt leverbaar NTB</i>		

Peddinghaus matrijs

Pedd. type	Ref. Mubea	Rond	Slf/Rechth	Vierkant
no. 2 (rd)	50673 - 2	22,81	60,11	77,24
no. 3 (grn)	50673 - 3	25,86	62,73	70,69
no. 4 (bl)	50673 - 4	45,62	101,93	102,10
no. 6 (bl)	50673 - 6	88,20	130,68	144,10
no. 7 (bl)	50675 - 7	65,39	112,20	118,00
no. 8	50675 - 8	74,51	119,00	122,55
no. 13 (rd)	50674 - 13	36,50	94,09	97,30
no. 14 (grn)	50674 - 14	45,62	101,93	107,10
no. 20 (bl)	50673 - 7	192,00	231,50	236,40
no. 57 **	50635	28,67	54,20	57,25

PRIJSLIJST SPECIALE STEMPELS & MATRIJZEN TBV KINGSLAND



[\(zie ook bijlage 3 op pag. 6 t.b.v. bepaling juiste type stempel & matrijs\)](#)

Kingsland stempel

Kingsland ref. rnd/slf	Ref. Mub.	Prijs rond	Prijs sleuf	Prijs vkt
K9000 /	50582-1...	22,93	<i>beperkt mog</i>	<i>beperkt mog</i>
K9001 / K9184	50556-5...	36,04	58,97	73,40
K9004 / K9185	50582-3...	55,58	70,56	87,24
K9006 / K9187	50582-4...	72,07	80,03	98,10
K9007 / K9188	50582-5...	131,04	168,60	172,00
K9009 / K9190	50582-6...	167,08	198,45	205,60
K9010 / K9191	50582-7...	193,28	228,50	232,20
K9011 / K9192	50582-8...	268,63	301,16	306,85

Kingsland matrijs

Kingsl. Ref. rnd/slf	Ref. Mubea	Prijs rond	Prijs sleuf	Prijs vkt
K9020 /	50696 - 1...	29,48	<i>beperkt mog</i>	<i>beperkt mog</i>
K9023 / K9221	50696 - 2...	62,24	75,82	78,25
K9024 / K9222	50696 - 3...	115,50	143,21	147,00
K9025 / K9223	50696 - 4...	183,46	243,40	246,30
K9026 / K9224	50696 - 5...	204,80	280,10	291,00

PRIJSLIJST SPECIALS DIVERSEN STEMPELS & MATRIJZEN (TBV ONBEKEND FABRIKAAT MACHINES)

DIVERSE stempels

Maatvoering (DxH)	Rnd spec.	Vkt spec.	Slf spec.

DIVERSE matrijzen

Maatvoering (DxH)	Rnd spec.	Vkt spec.	Slf spec.
Bijv. 50.0x15.5 NTB	46,27	78,52	89,50

PRIJSLIJST ALFRA APS/NITTO STEPELS & MATRIJZEN



ALFRA APS/NITTO stempel

Alfra APS/Nitto	Prijs rond	Prijs sleuf	Rnd spec.	Slf spec.
Serie 8 - 24mm *	18,03	47,40	42,34	54,07
- Rond: art. NKS241...				
- Sleuf: art. NKS243...				

* Rond standaard oplopend per 1mm, speciaalstempels ook mogelijk.

* Sleufgat standaard: 8x16 / 9x18 / 10x20 / 11x22 / 12x24 / 13x24 / 14x24 / 16x24 / 18x24 / 20x24.

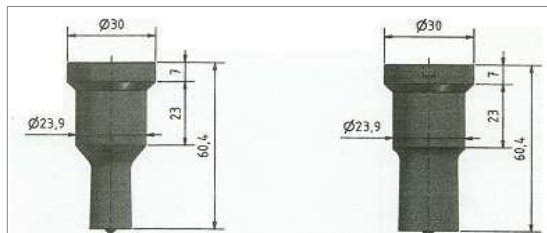

ALFRA APS/NITTO matrijs

Alfra APS/Nitto	Prijs rond	Prijs sleuf	Rnd spec.	Slf spec.
Serie 9-25mm *	15,66	47,40	39,65	50,83
- Rond: art. NKS241...				
- Sleuf: art. NKS243...				

* Rond standaard oplopend per 1mm, speciaalstempels ook mogelijk.

* Sleufgat standaard: 9x17 / 10x19 / 11x21 / 11x23 / 13x25 / 14x25 / 15x25 / 17x25 / 19x25 / 21x25.

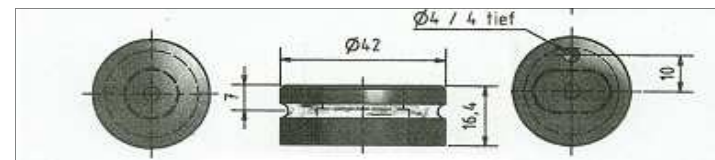

PRIJSLIJST FICEP STEPELS & MATRIJZEN



FICEP stempel

Ficep	Prijs rond	Prijs sleuf
Nr.1 (4 - 28mm)	<i>ntb</i>	<i>ntb</i>
Nr.2 (4 - 32mm)	15,65	36,89
Nr.3 (29 - 40mm)	<i>ntb</i>	<i>ntb</i>
Nr.4 (41 - 50mm)	<i>ntb</i>	<i>ntb</i>
Nr.5 (51 - 80mm)	<i>ntb</i>	<i>ntb</i>
Nr.6 (81 - 100mm)	<i>ntb</i>	<i>ntb</i>

FICEP matrijs

Ficep	Prijs rond	Prijs sleuf
Nr.1 (4.2 - 28.7mm)	<i>ntb</i>	<i>ntb</i>
Nr.2 (4.2 - 30.7mm)	15,35	36,24
Nr.3 (29.2 - 40.7mm)	<i>ntb</i>	<i>ntb</i>
Nr.4 (41.2 - 50.7mm)	<i>ntb</i>	<i>ntb</i>
Nr.5 (51.2 - 90.7mm)	<i>ntb</i>	<i>ntb</i>

